

## **19.0 – DIRTcar Sportsman Modified**

- ❖ Under the guideline of the 2024 DIRTcar rules any and/or rules and as stated in the 2024 DIRTcar Rule Book, all DIRTcar rules apply to all divisions. Local track rules pertaining to the racing procedures and/or overall rules that are administered by the local track officials and management may apply at local tracks in DIRTcar sanctioned events. Instances, where applicable, local track may be applied.
- ❖ All amendments supersede any previous rules regarding any technical article and/or aspect.
- ❖ Under the guideline of the 2024 rules any and/or rules and as stated in the 2024 DIRTcar Rule Book, all DIRTcar rules apply to all sanctioned divisions.
- ❖ The specifications published shall be considered a section of the “*Official Rules and Specifications*” for all events, series and sanctions by World Racing Group. All sections should be considered when determining specifications and governance.
- ❖ ANY CAR, TEAM AND/OR DRIVER THAT DOES NOT MEET THESE SPECIFICATIONS AND/OR EQUIPMENT REQUIREMENTS WILL BE SUBJECT TO PENALTIES AS DETERMINED BY THE Super DIRTcar and/or DIRTcar and/or World Racing Group OFFICIALS.
- ❖ Any new components, including engine components, body designs, frame designs and/or components of any type utilized in competition must be approved by World Racing Group, Super DIRTcar and DIRTcar Officials prior to being introduced into competition.

## **19.1 – Engines and Location**

- A. The General Motors (GM) / Chevrolet Performance Engine 602 is the only engine permitted in all DIRTcar Sportsman Modified events. The 2024 GM part number is #19434602, engine part number is subject to change.
- B. The engine and all components must remain in their original configuration and form as purchased and/or delivered from the factory. Any alterations to the engine will not be permitted, including treating or coating of any parts. The Engine must remain as manufactured by General Motors with a stock 4"-inch bore. Overbore(s) will not be permitted.
- C. All engines are to remain sealed from the factory or have DIRTcar, RYR or Pace Performance cable seals. The original factory seals or DIRTcar, RYR or Pace Performance cable seals must remain unaltered, tampering, removal, modifications of any type and/or broken factory seals will not be permitted. The GM Engine must remain unaltered in any way.
- D. The GM Crate Engine seals (bolt-type/bottle cap) must remain unaltered, tampering with and/or alteration of any seals will not be permitted and is subject to immediate penalty and/or suspension.
- E. Only GM replacement parts of any type will be permitted for any type of replacement and/or repair work. Only GM Crate Engine specific valve springs may be used for replacement and/or repair, Part Number # 10212811/19154761.
- F. The engine must be centered between the frame rails in the front of the chassis and placed in an upright position.
- G. Engine set back will be as follows; Minimum is 56"-inches and a Maximum of 66"-inches with a tolerance of ½"-inch (+/-). The setback will be measured from the centerline of the front axle to the rear-machined surface of the engine where the motor plate is attached to the motor.
- H. GM Crate Engine repairs must be authorized through DIRTcar Authorized Repair Centers, Don Blackshear and DIRTcar Technical Inspector. GM Crate Engine repair procedure works as follows:
  - a. Contact a DIRTcar Authorized Repair Center and/or DIRTcar Technical Officials before any sealed components are removed.
  - b. The DIRTcar Technical Officials will provide a list of DIRTcar Authorized Repair Center locations, or they are listed in 19.1.EV.
  - c. Based on the estimate and the detail of the repair, DIRTcar Authorized Repair Centers and Don Blackshear will determine if the repairs may be made or if a new engine must be purchased.
  - d. If a repair is approved, the Authorized Repair Center will perform all repairs to the GM Specifications.
  - e. Upon completion of the repair(s) the engine will be 'resealed' before being released for competition.
  - f. Bead blasting and/or any polishing and/or any alteration to the intake manifold and/or cylinder heads will not be permitted.

- g. All engine information regarding repairs and/or engine introduction will be retained by DIRTcar Officials and Don Blackshear, to track and manage engine database, including the driver, serial number, repair, type of repair and/or what type of service was performed to any engine.
- I. DIRTcar and/or World Racing Group Supervisory Officials reserve the right to technically inspect, exchange and/or confiscate any GM Crate Engine at any time. Failure to surrender the engine and/or submit the engine for inspection equals disqualification from the event and/or suspension.

**19.1.EV – Engine Verification.**

- A. All motors repaired through the Authorized Repair Centers will have a DIRTcar, RYR or Pace QR coded seal. The QR seal will retain information pertaining to the repaired motor.
- B. All current motors with GM Bolts/Bottle Cap seals or previously DIRTcar sealed must go through the verification program at an Authorized Repair Center and have a QR seal attached to the motor.
- C. A new motor may also be purchased from Authorized Repair Centers or GM Performance Dealer and be updated to a verified motor with a QR seal.
- D. Seals from other sanctioning bodies are not accepted as verification seals.
- E. Verification pricing is locked in among all centers at \$650 (US) and \$875 (Can.) plus needed replacement parts.

**Authorized Repair Centers:**

Petrucci Engines /Carlquist	Donath Motorworx	Enders Racing Engines	Hunts Machine
Competition Engines	4878 Rt. 20.	55 County Rte. 59	102 Weaver St.
98 Falls Ave.	LaFayette, NY 13084	Phoenix, NY 13135	Schenectady, NY 12305
Oakville, CT 06779	(315) 677-8116.	(315) 695-4491	(518) 372-7177
(203) 297-2815			

LaFrance Performance	DRIVR Performance	New Generation Engines	DMO Engines
16397 County Rd. 2	2925 Nelson	563 Hwy. 20	83 Bridge Street
Long Sault, ON K0C 1P0	Saint Hyacinthe, QC J2S 2V8	Fenwick, ON L0S 1C0	Plattsburgh, NY 12901
(613) 551-6212	(450) 230-1906	(905) 892-3255	(518) 563-2749

Hull Motorsports Racing Engine	955 Automotive
31 Smith Road	4725 Iroquois Ave.
Orange, VT. 05641	Erie, Pa. 16511
(802) 371-7027	(814) 897-9559

**Crate Program Overseen by – Don Blackshear – (724) 977-7424**

**19.1.1 – Carburetor / Air Cleaner**

- A. Only one (1) 650 cfm Holley carburetor, Part Number 4777C or Holley HP Carburetor Part Number **0-80541-1 or 0-80541-2** will be permitted. (\*\*\*) Note 0-80541-2 uses an 80541-3 main body.)
  - 1.) The 0-80541-1 & -2 carburetor must maintain the stock venturi and throttle bore dimensions; the primary and the secondary venturi must be 1 1/4". The 4777C primary venturi will be 1-1/4" and the secondary must be 1 5/16".
  - 2.) The carburetor (float bowls and main body) must be Holley original equipment manufactured. Metering blocks and base plate may be billet aluminum, Holley or after market.
  - 3.) The carburetor must maintain all stock dimensions, including mounting and stud location on intake manifold.
  - 4.) The booster height must remain stock OEM from Holley. Cutting, tumbling and/or polishing will not be permitted.
  - 5.) No visible modifications will be permitted to the OEM center section except the addition of the optional billet base plate and metering blocks
  - 6.) The following alterations will be permitted;
    - a. Holes drilled in the throttle plate for proper idle.
    - b. Drilling, tapping and plugging of unused vacuum ports.

- c. Welding of throttle shaft to linkage arm.
  - d. Drilling of idle and/or high speed air correction jets.
  - e. Milling of center carburetor body metering block surface, maximum of .015" on each side.
  - f. Removal of choke plate and shaft.
  - g. The jets may be changed as needed.
  - h. Boosters may be safety wired
- 7.) Gauge measurements (go/no-go) must meet Holey OEM measurements, including after-market base plates regardless of carburetor temperature at all times.
- 8.) Jets, bleeds, needle and seat, emulsion bleeds, power valves, accelerator pumps nozzles, accelerator pump cam adjustments and secondary adjustable linkage will be permitted.
- 9.) Physical alteration of carburetor components and/or parts and/or any alterations, machining and/or reshaping will not be permitted. The use of epoxy and/or coatings of any kind will not be permitted.
- B. A WRG approved carburetor roll over plate that prevents fuel spillage in case of a roll over is highly recommended.
- Currently approved roll over plate approved as followed,
- i. Willy's Carb & Dyno shop LLC. Part # WCD4000SB
  - ii. Willy's Carb & Dyno shop LLC. Part # WCD4002
- A. A single unaltered carburetor spacer plate with an unaltered single opening including gasket with a maximum thickness of 1-1/8"-inch will be permitted. A maximum two-inch (2") non-tapered air cleaner spacer may be added. Tapering, machining and/or any other alteration to the spacer plate will not be permitted.
- B. Only a single conventional round type air cleaner housing with one 5" round hole in the center will be permitted. Ram air hood (No forward-facing opening), air box and/or heat shield type devices will not be permitted. The air cleaner must remain in place when the hood is removed. A flat piece of metal may be added and securely fastened to AND LEVEL WITH the hood following the contour of the hood scoop to act as a dust shield. The metal attachment can follow the contour of the air cleaner and is not to go past the centerline of the carburetor. The rear 180 degrees of the bottom of the hood scoop must remain open and not enclosed. The opening behind the air cleaner must extend parallel to the air cleaner, to the rear of the hood enclosure/firewall. There cannot be any metal attached to the air cleaner. Air cleaner must be centered on carburetor.
- C. Air cleaners that provide ventilation through the top cover (such as the K & N brand) will be permitted.
- D. Air induction plastic carburetor insert and/or other air diffuser devices that direct air into the air intake will not be permitted.

#### **19.1.4 – Ignition/Battery**

- A. Only stock OEM distributors will be permitted. The distributor must maintain the factory mechanical advance curve to stock OEM specifications. Alterations and/or adjustments will not be permitted with the exception of welding the advance of the addition of lock out plates to the mechanical and vacuum distributor advance system. **The weight plate may also be added to the distributor shaft.** Also, a distributor gear shim may be added to reduce shaft end play. When both lock plates are added, mechanical weights and springs are to be removed along with the vacuum advanced canister.
- B. The ignition amplifier box ("rev box") and coil must be mounted under the hood and on a panel behind the air filter shielded from heat (out of the driver's reach) for ease of inspection. The black wire must be grounded to the motor. When the hood is removed the "rev box" must be clearly visible and not covered.
- C. The car must be fitted with one (1) unaltered approved MSD/DIRTcar RPM (rev) limiting box, maximum 6000 RPM. The box must remain operable and in working condition, prior to, during and after all racing events. The MSD 8727CT will be the only MSD/DIRTcar RPM (rev) limiting box permitted for competition.
- D. Only the stock OEM H.E.I. distributor, ignition coil and module will be permitted.
- E. The wiring must remain as specified by the ignition amplifier box manufacturer.
- F. One American Passenger Car sized battery with terminals on top and a maximum of 12 volts will be permitted. The voltage must not measure more than 14.3 volts anywhere in the system. Step up transformer and/or any other device designed to increase voltage will not be permitted.
- G. OEM stock firing order must be maintained for all engines. Standard GM Firing Order 18436572.

- H. Ignition amplifier boxes, “rev boxes”, RPM limiting chips, may be inspected, confiscated and/or exchanged at any time.
- I. The battery must be securely mounted inside the frame rails.
- J. All cars must have an ignition switch, which is easily accessible by the driver and/or safety crew and clearly labeled ON/OFF in the driver’s compartment. Motor must not run when in the off position.
- K. A battery shut-off switch is mandatory. The switch must be clearly labeled ON/OFF. The switch must be mounted on the left side inner panel (above the steering post). The switch must be outside the panel and easily accessed externally. The switch must be wired to shut off the hot (pos +) side and must not run when in the off position. See diagram in the back of this rule book.
- L. DIRTcar and/or World Racing Group officials reserve the rights to analyze and/or switch ignition boxes and/or rev chips at anytime.

### **19.1.5 – Lubrication/Oiling System/Oil Cooler**

- A. Oil coolers must be mounted under the hood or under the side wings/pods. Oil coolers mounted behind the driver exposed will not be permitted. Oil coolers that are not under the hood must have ducting covering them and remain below the bodywork. Unless mounted under the hood, the oil cooler must be mounted horizontal and flush with the cut out in the side wing/pod.

### **19.1.6 – Transmission / Driveline and Driveline Components**

- A. Only approved North American and/or Canadian manufactured manual shift transmissions will be permitted. Automatic and/or automatic-type transmissions will not be permitted.
- B. Overdrive and/or under-drive transmissions will not be permitted.
- C. Running through reduction gears will not be permitted. The transmission must be direct drive to the rear end.
- D. The transmission must have working gears. Forward, neutral and reverse must be working. From the neutral position and with the motor running, the car must be able to go forward and/or a backward in a smooth manner. The car must start and move under its own power.
- E. The transmission must bolt to the bell housing.
- F. Driveline components made of carbon fiber, titanium and/or other materials (considered exotic) will not be permitted.
- G. A maximum of two (2) universal joints per driveline will be permitted. No CV Joints allowed.

### **19.1.7 – Driveshaft**

- A. Only magnetic steel drive shafts will be permitted. Titanium and/or aluminum drive shafts and/or drive shaft yokes and/or driveline components will not be permitted.
- B. Only one (1) drive shaft connected from the transmission to the center section of the rear end will be permitted.
- C. Two (2) driveshaft hoops / closed rings a minimum ¼”-inch thick x 2”-inch wide magnetic steel must be positively fastened by two (2) 3/8”-inch grade 5 bolts to the frame and/or torque arm side plates installed around each universal joint.
- D. The drive shaft must have some type of drive shaft cover/shield. Cars with open drive shafts must have a drive shaft tunnel a minimum of 1/8”-inch thick by 6” wide magnetic steel extending from 2”-inches under the front edge of the seat and up the back of the seat 4” covering the transmission, drive shaft and the universal joint(s) and output flange on top and both sides. The tunnel must extend down to the floorboards. The cover must be positively fastened with a minimum of four (4) 3/8”-inch diameter bolts at the bottom connected to a cross-member. The cover must be a solid unit with no cuts and/or holes and/or removed material for the purpose of weight reduction. The only hole may be for the gear shift control.
- E. Carbon fiber, titanium, and/or other materials (considered exotic) will not be permitted anywhere in the car.

### **19.1.8 – Engine Cooling System/Radiator**

- A. **Cast iron and Aluminum water pumps will be permitted.**
- B. Only one (1) radiator will be permitted. The minimum width of the radiator will be 20”-inches when measured from the outside edge(s) of the radiator. The radiator must be mounted vertically in front of the engine. The minimum height of the radiator must be 22”-inches when measured from the bottom of the frame rail vertically and may incorporate the oil cooler to achieve the vertical height. Radiators mounted on an angle will not be permitted. Plastic and/or carbon fiber radiators will not be permitted.
- C. Auxiliary cooling tanks and/or overflow cans and/or canisters will not be permitted in the cockpit.

- D. The cooling fan for the radiator must be mounted in the stock OEM location on the front of the water pump. Fans mounted to the crankshaft will not be permitted. Electric fans and/or water pumps will not be permitted. No flex style fans allowed.

### **19.1.9 – Rear End**

- A. Only Quick-Change type rear ends will be permitted.
- B. Hypoid-type and/or Nine (9") Ford-type and/or limited slip-type and/or lockers and/or two speed rear ends will not be permitted. Non-Quick-Change Rear Ends not permitted
- C. Only aluminum and/or magnetic steel spools will be permitted.
- D. Only steel and/or aluminum rear spindles will be permitted. No camber rear-ends allowed. If the rear spindle is machined from aluminum, it must be a one-piece tube and spindle with a minimum outside diameter 2-7/8" and a maximum 2-1/2" inside diameter.
- E. Live rear ends with aluminum tubes will not be permitted. All others must be approved.
- F. Carbon fiber, titanium and/or other materials (considered exotic) for any rear end component will not be permitted. Tungsten or any other exotic metal are not permitted, in any form.
- G. A maximum rear end offset of 4"-inches from the center of the inside tire width when measured from the inside of the left rear tire to the inside of the right rear tire at axle height. Refer to the drawing at the back of this rule book.
- H. Aluminum rear end tubes only, with a maximum wall thickness of .410". Outer diameter cannot exceed 3".
- I. Outer collars (other than to attach bridge cage) are not permitted. Droop chain bracket may be steel, excessively thick or enlarged brackets of any type are not permitted. All other brackets must be aluminum unless authorized by DIRTcar.
- J. Drive Axles must not exceed 1.600" diameter and must be made of steel only. No tungsten. Inserts to be slid inside of tubes, made of any material, are not permitted.
- K. Ballast inside, attached to, or machined into hubs are not permitted. Maximum hub 10 lbs

### **19.2 – Fuel, Fuel Cells and Fuel System**

- A. Either meets FT3 or SFI 28.3 requirements and/or Include: a metal container, bladder, foam, top bolted fuel valve plate with flop valve or roll over check valve OEM cap. The fuel cell must have a maximum capacity of 24 US gallons and must remain in a rectangle and/or square shape for measuring and calculating capacity. The fuel cell must be mounted securely in its container and centered between the frame rails. Pressure tanks on fuel systems will not be permitted. Auxiliary fuel tanks will not be permitted. No dry ice or any other cooling agents will be allowed on the motor during competition. Fuel coolers of any type will not be permitted. A clearly marked fuel shut off valve, labeled On and Off, must be mounted within reach of the driver. It must be labeled with the word(s) "Fuel Shut Off". Refer to the drawing in the drawing section of this rule book.
- B. Only 'D'-type VP Racing Gasoline, the official fuel of DIRTcar will be permitted for competition. D-98 will be the only specified fuel permitted at any sanctioned DIRTcar Series event. In addition a maximum "94 octane, R+M/2" standard pump gasoline will be permitted at DIRTcar sanctioned weekly tracks. **Blending of fuels or gasoline including race fuels or fuels of different octanes will not be permitted. Fuel additive of any type will not be permitted. Fuel with 15% (E15) Ethanol or greater will not be permitted.** Alcohol, methanol, nitrous oxide, nitro-methane and/or propylene oxide will not be permitted. Fuel may be subject to inspection and testing at any time. Proof of purchase for the official fuel of DIRTcar may be required.
- C. The maximum capacity of the fuel when measured empty and/or dry will be measured in cubic inches utilizing the standard formula of length (minus 1/2"-inch) x width (minus 1/2"-inch) x depth (minus 1/2"-inch) will be 5,660 cubic inches.
- D. The foam in the fuel cell must remain unaltered. A minimal cut in the foam will be permitted in the shape of a square or a rectangle. The cut may be no more than 1,000 square inches. The foam must retain the factory cut.
- E. The fuel cell must be enclosed completely in a rectangle and/or square container that is a minimum thickness of 20-gauge magnetic steel. An aluminum container may be used as an option and must be a minimum of .060"-inch in thickness. On the bottom of the fuel cell, a piece of .090-gauge material (aluminum and/or magnetic steel – in addition to the existing container) must be used at the bottom of the fuel cell container to prevent bowing and/or deflection. The .090-gauge material must have an inspection hole drilled near the center of the piece to measure the thickness of the material. A 1"-inch x 1"-inch x .0625"-inch thick magnetic steel square tubing rack must be fabricated on the top, front and

rear sides of the fuel cell container. The square tubing must be a minimum of 5"-inches from the outside edge of the fuel cell on either side. The rack may be fastened to the bottom of the fuel cell can utilizing a piece of magnetic steel angle material that is a minimum of 1"-inch x 1"-inch with a minimum material thickness of .065"-inch magnetic angle steel that is on all four (4) sides of the container/Or the fuel cell must be mounted with a minimum of two (2) .125-inch thick steel straps a minimum of 1" (inch) wide. The straps must cover the entire cell. Fuel cells that are mounted in a square tubing frame will be permitted. A minimum of 5/6"-inch ASTN Grade 8 bolts must be used to mount the fuel cell to the frame. Drilling multiple holes and/or any attempt to lighten any piece within the fuel cell container and/or rack will not be permitted. The measurements taken in regard to the fuel cell container will be measured on an inside-to-inside basis. A tolerance for material thickness will be calculated and permitted for dimensions; however, there will be no tolerance for expansion and/or containers that are larger than the minimum.

- F. Only one (1) fuel filter with a maximum capacity of one (1) US quart will be permitted with one (1) carburetor fuel log with a maximum outside diameter of 1-1/2"-inches. The fuel log must remain straight without bends and/or curves and must be a maximum of 16"-inches in length Plastic and/or glass fuel filters will not be permitted.
- G. Fuel coolers of any type will not be permitted. No dry ice or any other cooling agents will be allowed on the motor during competition.
- H. The fuel cell must be mounted behind the driver rear axle between the rear tires, a minimum of 4"-inches ahead of the rear bumper.
- I. The bottom of the fuel cell container must be a minimum of 12"-inches from the ground.
- J. The fuel pick up must be positioned on the top of the fuel cell and be constructed of metal. The vent line must have a check valve.
- K. For the purpose of inspection, the driver and/or crew must be prepared to drain fuel upon request for inspection and/or measurement.
- L. For the Official Fuel of DIRTcar; the fuel provider's decals must be displayed on both sides of all DIRTcar racecars and a patch is required on the driver's uniform. Logos and/or the presentation of any other fuel manufacturer and/or fuel refinery on the racecar and/or driver's uniform will not be permitted.
- M. Only one mechanical fuel pump in the stock location will be permitted. Fuel must be delivered through the fuel system from the fuel cell to the mechanical fuel pump. Fuel systems that require a return line, a pressure regulator of any type and/or other volume and/or pressure altering device will not be permitted.

### **19.3 – Exhaust - Muffler and Sound Reduction Devices**

- A. Schoenfeld headers, model number: 1122BCM, 1122BUCM2 and 1122BCM2, Beyea headers Part # NEDM602, NEDM602US and Henry's Part # DMMSCT-DL will be allowed. The exhaust headers must be 1-5/8" outside diameter. Tri-Y, step headers, stainless steel, ceramic coated, and/or merge collectors will not be permitted. The permitted mufflers include: Dynomax part number(s): 17223 and 17296; Extreme Muffler part number(s): 31530 and 31230; Beyea part number: MUF3DM. Henry's DMMS3
- B. The header collector extension pipe and tail pipe must not be inserted past the muffler inlet or outlet flange and must exit behind the driver. Maximum of 3" exhaust pipe allowed throughout the exhaust system. No Stainless allowed anywhere in exhaust system.
  - a. All Spec headers must be able to be separated from the rest of the exhaust system for the purpose of inspection.
- C. The complete exhaust system must be sealed. Any type of add on, return system and/or exhaust evacuation system will not be permitted.
- D. The exhaust must exit past the driver and the exhaust must flow toward the rear of the car in an upward manner away from the racing surface. Exhaust systems that face the outside of the car will not be permitted.
- E. Each muffler must have a tail pipe that is a minimum of 10"-inches long when measured off the rear edge of the muffler. Complete exhaust system must be welded or bolted, band clamps may be added over welded joints.
- F. Cross-over and/or the joining of exhaust systems from side-to-side will not be permitted.

### **19.4 – Traction Control Devices**

- A. All electronic and/or computerized wheel spin and/or ignition retardation and/or acceleration limiting and/or traction control devices of any type will not be permitted.
- B. Adjustable ping control devices, dial a chip controls, timing controls and/or automated throttle controls will not be permitted.

- C. Adjustable restrictor plates will not be permitted.
- D. Remote control components of any-type will not be permitted.
- E. Radios and/or devices for transmitting voice and/or data will not be permitted, unless otherwise authorized prior to any event.
- F. Data acquisition systems will not be permitted.

## **19.5 – Chassis / Frame**

- A. All frames must be fabricated utilizing 2"x4" rectangular magnetic steel tubing with a .120" wall thickness. Only 2"x4" rectangular box frames between the front and rear axle centers will be permitted. The 4"-inch side of the rectangular tubing must remain in the vertical position. No open holes or drilling holes in frame rails will be permitted. Round tubing must be either 1-1/2" outside diameter (if used for main hoop must be .125") and/or 1-3/4" outside diameter with wall thickness of .095"-inches.
- B. Frame width will be as follows; At the front shock towers a minimum 24" and a maximum of 35"-inches. Rear of the car is a minimum of 26" with a maximum of 35"-inches. The minimum frame width at the rear roll bar must be 26"-inches. All measurements will be taken from the outside of the frame rails, at the top and bottom of the frame rails and its longest length. Clips, sub-frames, etc., will be considered a part of the frame.
- C. The minimum length of the 2"x4" frame rails begins 14"-inches in front of the centerline of the rear axle and extends to the front of the radiator. The left and right rails (both top and bottom) must be equal in distance from the driveline centerline along the total length of the frame. Offset frame rails will not be permitted. A maximum 4"-inch indent in the lower left rear frame rail for suspension clearance will be permitted. The two (2) upper frame rails in the engine compartment may be altered for engine clearance only.
- D. The kick-ups must meet the same specifications as the roll cage and/or frame material.
- E. Titanium and/or carbon fiber material(s) will not be permitted on the chassis and/or frame.
- F. There must be a minimum of 2-1/2"-inches ground clearance from the chassis at its lowest point.
- G. Ground effects will not be permitted.

### **19.5.1 – Seat Location and Mounting in Frame**

- A. The seat and steering wheel must be centered in the frame. Offset mounting of the seat and/or steering wheel will not be permitted.
- B. The bottom rear of the seat must be a maximum of 16"-inches from the centerline of the rear axle. Refer to the drawing at the back of this rule book.

## **19.6 – Weight / Ballast**

- A. All cars will be weighed with the driver seated in the car. The minimum weight permitted before and/or after an on track event will be measured by the track scales. The track scales will be the official scales. All cars found to be light prior to any event, time permitting will be allowed to make the necessary adjustments and represent themselves at the scales. The number of cars to be weighed after an event will be announced at the driver's meeting and/or on the one-way radio. If a car is signaled to go to the scales in any fashion and does not report to the scales at the appropriate time, that car may be disqualified from the event. Any car that is found to be light following time trials and/or a qualifying event will be disqualified from that particular race and may make the necessary adjustments and represent themselves for that car's assigned consolation event. If a car is found to be light after the feature event, that car will be disqualified from the event.
- B. The minimum weight following the completion of any DIRTcar Sportsman race will be 2400 lbs.
- C. Ballast and/or weight may not be mounted to the roll cage above the rear deck. All added weight must be securely attached to the frame below the body decking.
- D. Frame is defined as the steel welded structure only.
- E. Any part that moves or is not a fixed component to the steel frame structure may not be used for any weight attachment.
- F. Weights attached to the rear bumper and/or outside the frame will not be permitted.
- G. All weights and/or ballast must be positively fastened and mounted within the vertical planes formed by the frame rails and must remain stationary during competition. All weight(s) must have a minimum of two (2) 1/2"-inch diameter grade 5 bolts and/or studs passing completely through the weight. Bolts and/or studs must be anchored with a minimum of two weight clamps to the frame. Bolts and/or studs welded to the frame will not be permitted.

- H. All weights must be painted white and clearly labeled with the car number on it. Lead or tungsten may be used for ballast, pellets or liquid type weight ballast will not be permitted. **All materials must be approved.**
- I. All added weight(s) must be securely attached to the frame below the body decking.

## **19.7 – Body**

### **BODY STYLE AND DIMENSIONS**

ALL MEASUREMENTS WILL BE TAKEN WITH DRIVER AND/ OR WITH OR WITH OUT FUEL. TOLERANCE PERMITTED ON ALL BODY DIMENSIONS IS MAXIMUM OF +/- (PLUS OR MINUS) ½"-INCH (ONE-HALF INCH). THIS IS A TOLERANCE, NOT A DIMENSION THAT IS INTENDED TO BE ADDED TO THE BODY DIMENSIONS.

**\*\*\*\* Note – DIRTcar officials can make a competitor change aspects of any body and/or body panels at any time during an event.**

#### **19.7.1 – General Body**

- A. Mirrors and/or reflective devices will not be permitted.
- B. A full magnetic steel windscreen and/or rock guard is required. The windscreen and/or rock guard must have an individual hope opening of 2" x 1" with a minimum of 1/16" thickness. Chicken wire type and/or aluminum screens will not be permitted. The windscreen and/or rock guard must cover the entire windshield area across the front of the roll cage and from the top of the roll cage down to the base of the cowl and/or hood. In addition, clear lexan-type and/or safety glass windshields will be permitted. If the lexan and/or safety glass is utilized it must be shatterproof and mounted behind the windscreen and/or rock guard. Any additional windshield must not obstruct the driver's exit of the vehicle. Recommended is 3 upright, quarter inch bars behind the screen for added strength.
- C. Offset bodies will not be permitted, all body panels must symmetrical unless noted in the rule book.

#### **19.7.2 – Body Material**

- A. Only magnetic steel and/or aluminum will be permitted for all inner and outer body panels.
- B. Vertical material (plastic and/or rubber-type), with a material thickness between .090"-to-.125"-inch and a minimum height of 8"-inches from the bottom of the quarter panel will be permitted, provided both doors and/or quarter panels maintain the same length and height with or without the plastic (symmetrical). An overlap of two (2") inches to secure the door(s) extensions will be permitted. The door(s) must maintain a minimum of six (6") inches of ground clearance including the additional material extending below the metal body. The overall dimensions of the door(s) and extensions must meet the specifications.
- C. Only a single piece fiberglass roof will be permitted.
- D. Only fiberglass and/or aluminum hood, hood scoop, windshield cowl, rear interior tire clearance cover will be permitted
- E. Only clear lexan will be permitted for the rear wing windows. Decals and/or lettering will not be permitted on the rear spoiler and/or rear wing windows.

#### **19.7.3 – Roof**

- A. A one-piece fiberglass roof, single ply, one contour inside and out will be permitted. Carbon fiber and/or any other composite type materials will not be permitted. All roll bars must remain exposed. Vertical material of any type used to mount the roof that may cover the roll bar will not be permitted.
- B. The roof must be centered from side-to-side on the roll cage and on the frame. The leading edge of the roof must be positively fastened in a stationary position a minimum of 33"-inches and a maximum of 48"-inches in front of the rear axle centerline. The roof must be securely and positively fastened on all sides.
- C. The minimum length of the roof is 47"-inches with a maximum of 60"-inches. The minimum width of the roof is 48"-inches with a maximum of 52"-inches. **The roof cannot be "dished" front to back or side to side.** The maximum front lip must be ½"-inch. The maximum side edge(s) must be 1-1/8"-inch break. Refer to drawing on page 86 and 88.
- D. Changes to the shape and/or location of the roof at any time during competition will not be permitted.
- E. The maximum overall height of the car is 62"-inches with a minimum of 53"-inches measured from the ground.
- F. The maximum roof angle is **10 degrees with no tolerance** when measured with the DIRTcar gauge. (See reference drawing).
- G. Any proposed roof design that deviates from the preceding rules must be submitted to DIRTcar for approval and approved before being presented for competition.



#### **19.7.4 – Front Door Posts**

- A. Only a one (1) piece magnetic steel and/or aluminum front door posts and/or 'A'-pillars a minimum of .050"-inches with a maximum of .090"-inches will be permitted. The front door posts must be securely mounted to the roof and to the door(s). The side of the front door post must measure a minimum and maximum of 2"-inches. The front door post may be bead rolled and/or have a lip and/or flange for re-enforcement, but the re-enforcement must not exceed a maximum 3/8"-inch in width.
- B. The door post may be fastened with a minimum of two (2) 3/16"-inch bolts to the door bracket for ease of fabrication. The Door post must not extend past the vertical plane of the door.
- C. Additional material, air directional devices, lexan vent windows and/or excessive material will not be permitted in the corner of the front door post, where the post meets the door panel.
- D. There will be no tolerance on the front door post measurements.

#### **19.7.5 – Rear Wing Windows / Side View / Rear View**

- A. All rear wing panels and windows must resemble a current production OEM style body. Only manufacture approved rear wing panels and windows will be permitted for competition. Any non-manufacture rear wing panel must resemble and/or meet the criteria as the submitted rear wing panels and/or windows. Any rear wing panel that is submitted for competition must not exceed 815 square-inches in total area. *All rear wing panels must be submitted for approval prior to introduction into competition.*
- B. The upper profile must not extend above a straight line projected from the rear of the roof to a point 3"-inches higher than the rear deck. A minimum 2"-inch indent in the profile, so as not to make the panel a fast back is mandatory. (Please refer to the drawing and photographs)
- C. The maximum base length will be 61"-inches. The left and right must be of the same style and dimensions (symmetrical). (See example of Body Style Drawing)
- D. All rear wing(s) must have an opera-type window. The window must be lexan. Lexan and aluminum must have one continuous, curved bow. Bends or breaks in the Lexan area of the window will not be permitted. Lexan must also be the bulk of the space.
- E. Decals and/or lettering will not be permitted on the rear windows.
- F. The rear view of the wing window must go in a straight line from the top of the quarter panel (tangent) or bodyline to the roof with a maximum gradual bow of 2"-inches in the center of the wing window.
- G. Flanges and or additional material added to the rear window panel for the purpose of directing air flow will not be permitted.

#### **19.7.6 – Body Width and Ground Clearance**

- A. The body width, when measured at any point along the body line from front-to-back will be a maximum of 68"-inches and a minimum of 64"-inches.
- B. A minimum chassis ground clearance of 2 ½"-inches will be permitted.
- C. Fan and/or ground-effect cars will not be permitted.
- D. Rubber skirts, fins, air directional devices and/or spoilers of any type under the car will not be permitted. A 2" inch maximum air deflector in front of the radiator for engine cooling will be permitted.

#### **19.7.7 – Door Panels**

- A. The side door panel(s) will be a maximum of 86" inches and a minimum of 60"-inches in front of the centerline of the rear axle when measured along the top plane. The door(s), front door extensions and rear quarter panels must be flat and mounted in a vertical position. They must remain flat. Flanges at a 90-degree angle may be added to the front of the doors. The flange may only be added for the purpose of strengthening the door material. The flange must not exceed ¾"-inch in length or width and must be mounted in a vertical position. Door flanges must face inward toward the centerline of the chassis. Louvers, bead rolls holes and/or protrusions from top-to-bottom will not be permitted. Holes will be permitted for rub rails/nerf bars. A maximum 1"-inch long lip/flange at a 45-degree outward angle ½"-inch away from the sheet metal for reinforcement will be permitted at the top and bottom of the door(s) panels. All outside sheet metal, door panels, door extensions, air dams, front nose and/or hood fins must be the same shape, size and angle on both sides of the car. The door(s) must match each other from side-to-side (symmetrical). Air directional devices and/or side mounted spoilers of any type, which extend past the outside edge of the flat plane of the body will not be permitted.
- B. Bead rolls around the outside perimeter of the door panels and the wing windows will be allowed. Bead rolled edges must face toward the center of the chassis.
- C. The top of the door when measured from the ground will be a maximum of 38" and a minimum of 30"-inches when measured 60"-inches from the rear axle centerline. The rear of the door when measured

from the ground will be a maximum of 42"-inches to the top of the door when measured 16"-inches from the center of the rear axle centerline of the rear forward.

- D. The ground clearance on the bottom of the doors must maintain a maximum of 12"-inches and a minimum of 6"-inches from the ground.
- E. A maximum lip and/or flange of 1-1/2"-inches rounded at 90 degrees and facing inward only, on the top and bottom door(s) and rear quarter panel(s) will be permitted.
- F. A lip and/or flange angled out at a maximum angle of 45 degrees, extending away from the door at a maximum of 1/2"-inch and a maximum of 1"-inch in length before it bends inward for strength at the top of the door(s) and/or rear quarter panel(s) will be permitted.

#### **19.7.8 – Rear Quarter Panels**

- A. The rear quarter panels must be symmetrical in height, with or without plastic, and no holes.
- B. The rear quarter panels must be a maximum of 47"-inches and a minimum of 40"-inches from the ground at the rear and continue in a straight line with the top of the door. (See drawing.).
- C. A maximum 2"-inch fender flare may be used, but the overall body width must maintain a maximum of 68"-inches.
- D. The rear quarter panels may extend rearward a maximum of 48"-inches when measured along the top plane of the rear quarter panel and a minimum of 44"-inches at the bottom when measured from the center of the rear axle to the rear of the car.
- E. A maximum of 16"-inches and a minimum of 8"-inches of ground clearance (when measured from the ground to the bottom of the rear quarter) will be permitted.
- F. The plastic / rubber material utilized on the rear of the car may extend a maximum of 16"-inches from the ground to a minimum of 8"-inches from the ground on either side of the car (symmetrical).
- G. The panels may have one side plastic on one (1) side only provided the panel remains completely symmetrical.
- H. Flanges at a 90 degree angle may be added to the Rear Quarter Panels. The flange may only be added for the purpose of strengthening the Rear Quarter Panel. The flange must not exceed 3/4"-inch in length or width and must be mounted in a vertical position. Rear Quarter Panel flanges must face inward toward the centerline of the chassis. Air directional devices and/or side mounted spoilers of any type, which extend past the outside edge of the flat plane of the body will not be permitted.

#### **19.7.9 – Rear Spoiler**

- A. No spoiler of any kind
- B. Nothing above the rear deck edge, no lips facing forward of the rear deck of any kind.

#### **19.7.10 – Rear Deck**

- A. The maximum height of the rear deck when measured from the ground will be 47"-inches and a minimum of 40"-inches.
- B. The rear deck lid must be fully enclosed from side-to-side and have a maximum height of 10 1/2 "-inches vertically behind the fuel tank.
- C. The left and right rear trunk lids must be symmetrical in size and shape and must remain flat to cover the fuel filler hose and apparatus. The panel must completely cover the fuel cell, the fuel filler hoses and the vent lines.
- D. Fuel tank must be completely enclosed from the bottom of this panel (rear deck) to the bottom of the fuel cell. (2020 Rule)
- E. Openings from the top of the fuel cell to the bottom of the trunk lid will not be permitted. (2020 Rule)
- F. (Optional) The fuel tank sides must be completely enclosed on each side from the front to the rear of the fuel cell and from the bottom of the cell to the rear deck. No holes and/or openings permitted in the side panels. The rear area of the fuel cell from the rear deck to the bottom of the cell must remain open.
- I. Nothing above the rear deck edge, no lips facing forward on the rear deck of any kind. Air directional devices of any type, which extend past the rear deck edge will not be permitted.

### **19.7.11 – Hood, Nose and Front Spoiler**

- A. The maximum width for the hood, nose and front spoiler will be 36"-inches with a minimum width of 24"-inches. Louvers or **openings with mesh behind will be permitted on one or both sides** of the hood.
- B. **Only rear facing louvers will be permitted on the top of the hood.**
- C. The hood, nose and front spoiler must remain the same contour where they meet.
- D. The nose-piece must not extend rearward of the front shock towers.
- E. The front spoiler must be a separate piece.
- F. Shock absorber covers and/or deflectors must not be a part of the nose or the spoiler and/or positively fastened to the nose in any fashion exceeding the 36"-inch maximum width.
- G. Fabric material shock absorber covers will be permitted. The covers must not be used to achieve any aerodynamic advantage and/or to deflect air in a positive manner.
- H. The maximum the spoiler may extend in front of the front axle centerline will be 20"-inches.
- I. The front spoiler must be non-adjustable (hinges and/or sliders will not be permitted). Minimum ground clearance of 4" (inches)
- J. The hood shall be considered from the front roll cage to on top and in-line with the front of the radiator.
- K. The hood and nose may have a maximum lip and/or flange of 2"-inches on both sides following the contour of the body. They must remain symmetrical.
- L. The hood and nose be centered on the centerline of the frame.
- M. The hood, nose and/or spoiler must not overlap each other's location on the frame.
- N. Any part of the hood must not exceed 10 degrees and the sheet metal must not have an opening and/or extrusion between the hood and the nose.
- O. The hood must extend over the radiator and have complete sides.
- P. The front spoiler may have a lip and/or flange a maximum 2"-inches on both sides following the contour of the spoiler not exceeding the maximum width of 36"-inches. The front spoiler may be offset 1"-inch from the centerline of the frame to the right or the left. One 2" high wicker bill may be added horizontally to spoiler in front of shock towers.

### **19.7.12 – Hood Scoop**

- A. There is one type of hood scoop that can be mounted on top of the hood for the purpose of enclosing the carburetor.
- B. A minimum of 8"-inches will be required from the highest point on the hood scoop to the lowest point on the front of the front of the roll cage and/or the roof. The hood scoop must be positively fastened to the hood and completely enclose the carburetor and the air filter.
- C. The conventional air scoop will have a maximum of 25"-inches in length from the center of the carburetor forward to the end of the hood scoop and a maximum width of 22"-inches will be permitted. Forward facing openings in hood scoop will not be permitted.
- D. No add on air deflectors above the top plain of the hood scoop.
- E. The only openings on the side of the hood scoop has to be behind the air cleaner, the air cleaner cannot be visible from either the front, above or side views.

### **19.7.13 – Interior Sheet Metal**

- A. All horizontal body support(s) other than the inner pods, whether in the front and/or rear must be a minimum of 1" x 1" .095"-inch thick tubing or 1"-inch flat stock a minimum of .125"-inch thick..
- B. Inside and/or outside wings, spoilers, air foils and/or wind deflectors will not be permitted.
- C. Double panels and/or sheet metal that is designed to create a wing effect will not be permitted.
- D. A maximum 1"-inch reinforced flange will be permitted on all lexan; however, all specified measurements must be retained.
- E. All interior sheet metal must completely cover all interior areas, door-to-door, quarter panel-to-quarter panel. Holes and/or openings will not be permitted in this area.
- F. Front and rear firewalls are required. The front firewall must isolate the cockpit from the engine compartment. The rear firewall must extend from the top of the fuel cell to the belly pan to isolate the

cockpit from the fuel cell. The firewall must be a minimum of .050"-inch thick aluminum and/or magnetic steel. The firewall may be altered and/or cut for drive shaft clearance.

- G. Vertical fins, air dams and/or fairings on either side, behind the roll cage will not be permitted.
- H. All sheet metal must be a flat single plane across the interior of the car. Two (2) bead rolls or breaks for the purpose of strengthening will be permitted. The maximum bead roll and/or break permitted will be 1/8"-inch in height and 1/2"-inch in width.
- I. Covered roll bars will not be permitted. Sheet metal that is one-piece and/or part of a body panel formed around tubing that is not considered an aerodynamic advantage will be permitted, provided there is no excess sheet metal.
- J. Louvers will be permitted for cooling purposes only, including the radiator, engine and/or working oil cooler. Louvers and/or holes in the interior or exterior sheet metal will not be permitted.
- K. The floor and/or belly-pan may not be any wider than the frame at any point. Lips, fins and/or air directional devices on the floor and/or belly pan will not be permitted. Louvers for the purpose of cooling will be permitted on the belly pan from the radiator to the firewall. The under pan must not extend in length past the rear of the seat and exceed the width of the frame rails of the car and must be a maximum of .090"-inches in material thickness.
- L. Only aluminum belly pans will be permitted. Panels under the rear and and/or the fuel tank will not be permitted.

#### **19.7.14 – Driver Compartment**

A full metal firewall fabricated from magnetic steel and/or aluminum must encompass the driver's compartment from front-to-rear, on both sides and floor boards.

##### **Containment Seats**

Seats must be "Full Containment" style constructed of aluminum to the general design specifications of current industry standards (SFI 39.2). Design shall include comprehensive head surround, shoulder and torso support system, energy impact foam, and removable head foam. Consult with your seat manufacturer for questions and recommendations regarding your seat safety system.

- A. Seats manufactured using carbon fiber or composite materials must meet SFI 39.2 specifications.
- B. The seat design should be one from a current manufacturer and/or recommended to include the full containment design. Installation of the full containment seat should follow the manufacturer's instructions.
- C. All cars must be equipped with a quick-release type steering wheel.
- D. The driver compartment must have a starting switch and/or button within reach of the driver.
- E. A clearly labeled electrical on/off 'kill' switch must be within reach of the driver and must shut off motor when in the off position.
- F. Mirrors of any-type will not be permitted.
- G. Radios and/or electronic and/or data communication devices will not be permitted.
- H. Any edge and/or sheet metal end in and around the driver compartment must be protected with trim and/or beading and rounded. Sharp and protruding edges will not be permitted.
- I. A substantial rock guard with a minimum of three (3) additional bars must be mounted in front of the driver. The rock guard must be made from wire screen. Windshield screens must be a minimum of .090-inches and must be securely fastened.
- J. Fuel and/or power steering lines and/or fittings running through the driver's compartment must be made from an approved braided type of line. High pressure lines and/or fittings and/or hot fluid lines running through the driver's compartment must be encased and/or must have a shield.
- K. Shoulder guards will be allowed on the right side of the drivers compartment but the entire panel must be built to be a form of a quick release. Front and rear edge to be attached by a Butterfly Dzus fastener on the outside or a quick release button. Recommended front edge should have a quick release type of fabrication built or attached with Velcro. Back edge to be attached by Butterfly Dzus Fastener on the outside or quick release button. The opening from the bottom of the roll cage to top of arm guard is no less than 12 inches from front to back.

#### **19.7.15 – Numbers and Identification**

- A. The track and/or series Scoring Director reserves the right to issue and/or change a car number to prevent duplication and/or maintain proper records.

- B. Team cars must be clearly identifiable from one another and use another number and/or letter.
- C. All number and letter combinations will be limited to three digits. If three digits are used two (2) shall be the primary numbers/letter.
- D. Number and/or letter combinations are required on the roof, nose, rear deck and both doors.
- E. All numbers and letters must be a minimum of 18"-inches high on the roof and/or doors and 6"-inches high for the rear deck and 8"-inches the nose. All numbers and/or letters must be equal in size and displayed legibly whether decal and/or painted.
- F. The nerf bars must not block the visibility of the number and/or letter combinations.
- G. Light bars will be permitted however, they can only be a maximum of eight (8) inches in length and cannot be the colors of yellow, red or green.

### **19.7.16 – Bumpers and Side Bars/Nerf Bars**

#### **General**

- A. All bumpers, side bars/nerf bars and/or bracing must be made from minimum 1-1/2 diameter round .095-inch thick magnetic steel tubing only unless otherwise specified (**See below for front bumper specs**). All edges and/or corners on bumpers and side bars/nerf bars must be rounded. Sharp edges will not be permitted.
- B. The rear bumper and/or any side bars must not extend past the outside of the tire sidewalls on either the left and/or right side of the car.

#### **Front Bumper**

- A. Only the front bumpers may be made from minimum 1-1/4 diameter round .095--inch thick magnetic steel tubing.
- B. The front bumper must consist of two (2) horizontal rails; an upper and a lower and a minimum of two (2) vertical braces, equally spaced, welded between the two (2) horizontal rails. The horizontal rails must be positively fastened with bolts or pins to the frame with four (4) sockets and/or supports. The front bumper must remain exposed without covering and/or any sheet metal fabrication surrounding it.
- C. The four (4) tubes that support the bumper from the four (4) frame sockets must be horizontal. These rails must be a minimum of 6"-inches and a maximum of 12"-inches apart when measured from the top to the bottom and maintain that measurement for a minimum width of 24"-inches and a maximum width of 30"-inches. The front bumper must also have an 18"-inch center when measured from the ground up to the middle of the bumper. The total width of the front bumper must not exceed 30".
- D. The maximum the front bumper may extend from the centerline of the front axle is 24"-inches and a minimum of 20"-inches.
- E. The front surface of the bumper must remain flat, parallel and perpendicular with the front of the nose piece for the full width of the bumper. V-shaped and/or any other type of shaped bumpers will not be permitted.
- F. The end bracing tube of the front bumper must be fabricated on an angle in such a way as to prevent the bumper of another car becoming interlocked. Please refer to the drawing at the back of this rule book.

#### **Rear Bumper**

- A. The rear bumper must consist of two (2) rails, an upper and lower, which must have a minimum of four (4) sockets and horizontal support bars positively fastened with bolts or pins attaching it to the frame. The upper and lower rails must also be a minimum of 10"-inches apart and a maximum of 16"-inches apart from the top to the bottom and maintain that measurement for a minimum width of the 64"-inches and a maximum of 86"-inches.
- B. The rear bumper must have an 18"-inch center when measured from the ground to the middle of the bumper.
- C. The maximum the rear bumper may extend back when measured from the centerline of the rear axle is 52"-inches.
- D. The rear surface of the bumper must remain flat and parallel with the back of the rear quarter panel for the full width of the bumper. V-shaped and/or any other type of shaped bumpers will not be permitted.

#### **Rub Rails**

- A. Solid rub rails and inner hoops with ballast added inside or outside will not be permitted.
- B. The rub rails must be exposed and outside the body panels. The left side rub rail may extend a maximum of 2"-inches outside the left rear tire sidewall.

- C. The rub rails must be bent with a gentle radius at a 90-degree angle and must protrude a minimum of 6"-inches back in past the body.
- D. The rub rails must be a minimum of 50"-inches long from socket-to-socket
- E. All three attaching points must be fastened with bolts or pins.

### **Bumpers and Rub Rails**

- A. Only a minimum of 5/16" bolts with nyloc nuts and/or DIRTcar approved quick release solid pins will be permitted for positively fastening bumpers and rub rails to the car. Cotter pins and/or other fastening devices will not be permitted. Double rub rails will be allowed on Modifieds, 358 and Sportsman on left side only. Single rub rails only allowed on right side.
- B. All bumpers and rub rail sockets must have fasteners, pins and/or bolts with a minimum diameter of 5/16"-inch.
- C. The front and rear rub rails must have a 360 degree sleeve a minimum of 3/8"-inch wide x .095" thick magnetic steel welded to the rub rail tube butted against the support socket to prevent pins from shearing. Refer to the drawing at the back of this rule book.

## **19.8 – Suspension**

- A. Suspension designs and applications are constantly evolving. Although the intent of the suspension rules are an attempt to accommodate the majority of suspension and suspension component designs and applications currently being used in competition, the rules cannot be absolute. Any and all new designs or modifications to an existing suspension and/or suspension component must be communicated to and approved by the DIRTcar Racing before being used in competition.

### **19.8.1 – Front End**

- A. The front axle must be a straight, one-piece axle manufactured from magnetic steel tubing. Only approved camber adjustments and/or camber adjustment devices will be permitted. Any other camber adjustments and/or will not be permitted.
- B. Split axles and/or dropped axles and/or independent front suspension(s) will not be permitted.
- C. All brackets on the front axle must be welded and/or bolted. Bird cages and/or sliders will not be permitted.
- D. Only approved Modified front spindles will be permitted.
- E. Bearing shafts that are made of steel are recommended.
- F. The chassis may be offset a maximum of 4"-inches from the center of the inside tire width measured from the inside of the left front tire to the inside of the right front tire at axle height. Refer to the drawing in the back of this rule book regarding front and rear end offset details.
- G. The front wheels and tires must remain fully exposed. Fenders and/or air deflection devices of any type will not be permitted.

### **19.8.2 – Shock Absorbers**

- A. Only the DIRTcar approved A-B-C type shock absorbers will be permitted to compete.
  - a. The total visible shock shaft length must match OEM manufactured specifications.
  - b. Base valves can not be added or permitted to our approved shocks.
  - c. **Non-adjustable fill port is allowed. The corners of the center allen head bolt must be drilled and rounded off. No adjustments allowed, this is only for repairs**
- B. Shock absorber claim \$275 (\$340 Can.) per shock, no exchanges. (See bulletin for claiming parameters)
- C. **Approved Shock Absorbers:** All shock absorbers for the DIRTcar Sportsman Modifieds, DIRTcar Pro Stock, DIRTcar Pro Late Model, DIRTcar UMP Sportsman and DIRTcar UMP Stock Car division must be approved. There will be three types of approved designations, 'A', 'B' and 'C'.

#### **Approved 'A'-type Shock Absorbers:**

DIRTcar Sportsman Modified  
DIRTcar Pro Stock  
DIRTcar Pro Late Model  
DIRTcar UMP Sportsman  
DIRTcar UMP Stock Car

Pro Shocks – WB and SS Series  
Bilstein – AK and SG/SM Series  
AFCO – 1020-1034 Series  
AFCO – 1273-1295 Series  
AFCO – 1473-1497 Series  
Integra 421 Series

**Approved 'B'-type Shock Absorbers:**

DIRTcar Sportsman Modified  
DIRTcar Pro Late Model  
DIRTcar Pro Stock

Pro Shocks – TA Series  
Bilstein – SL/SZ Series  
Bilstein – SLS Series  
AFCO – 19 Series  
AFCO - 24 Series  
AFCO - 74 Series  
FOX – 983-97-507  
FOX – 983-97-509

**Approved 'C'-type Shock Absorbers:**

DIRTcar Sportsman Modified  
DIRTcar Pro Late Model

Bilstein – SL/SZ Series  
Bilstein – SNS Series  
AFCO – 1300 Series  
AFCO – 2100 Series  
Genesis – GD Series (Steel Body)  
Integra – 310-45170 or 310-45190  
FOX – 983-91-507  
FOX – 983-91-509  
DIG – 7507/7509 (Steel Body)  
Penske – 7100

Shock Absorbers must be submitted to World Racing Group for competition approval prior to the application of the shock absorber designation decal.

**19.8.3 – Suspension Components**

- A. Independent front and/or rear suspensions will not be permitted. No Cantilever suspensions allowed.
- B. A-Frames and/or ball joints will not be permitted for steering axis (kingpin only).
- C. Four-wheel steering actuated by the steering wheel and/or of any type will not be permitted.
- D. All suspension systems (including travel limiters) and designs must be mechanical. Hydraulic, pneumatic (air), electronic, radio and/or computer assisted for adjustments, and/or in-or-out of cockpit type suspensions, and/or suspension adjustment systems will not be permitted. Only one travel limiter permitted per car.
- E. Traction control of any type, including within the braking system is not permitted.
- F. Only a single brake bias and shut off will be permitted in the cockpit. Rear panhard bar adjustment devices will not be permitted in the driver compartment. Any rear panhard adjustments that have a knob and/or an adjustment device outside of the cockpit must be wired in a fixed position for competition.
- G. Only double-sided (two) torque arms will be permitted and must be mounted in a fixed perpendicular position to the rear end. Front slider rods and the torque arms attaching point must be centered in chassis (left to right). Both sides of the torque arm assembly (right and left) must be symmetrical in size and shape. Both sides of the torque arm assembly (right and left) must be attached to the center pick up point.
- H. Spring rods allowed on right rear radius rod only. Must be a conventional approved spring rod. No externally mounted shocks attached to radius rod. No Rubber biscuits allowed on the left rear radius rod.
- I. Only conventional type aluminum birdcages. All Bird cages must be clamped or fixed to rear end tubes and cannot move. Maximum bracket thickness 2" (inches). Any new birdcage designs must be approved.
- J. The only materials used to fabricate axle housing mounts (birdcages) that will be permitted is aluminum unless authorized by DIRTcar. Axle housing mounts fabricated of exotic, heavy materials will not be permitted.
- K. When fabricating axle housing mounts detail must be paid to functionality. The completed axle housing mounts, when comparing the right and the left side, must be as similar in design as possible.

**Rear Suspension Attaching (Radius) Rods**

- A. Only one radius rod per side will be permitted to locate rear end to chassis. (No Four link style suspension will be permitted).
- B. Radius rod must be mounted in a fixed position front and rear.
- C. The only materials used to fabricate attaching (radius) rods that will be permitted are magnetic steel or aluminum

- D. Aluminum attaching (radius) rods must be tubular material only. Magnetic steel attaching (radius rods) must be tubular with a maximum wall thickness of 3/16 inch.

#### **19.8.4 – Springs**

- A. Any type and/or form of spring will be permitted (torsion bar or coil spring). One per corner, no helper springs will be permitted
- B. Stacked coils and of any type are not allowed in the sportsman division. No progressive springs allowed. A maximum of one 2 ¼ inch high foam type rubber (no neoprene) will be allowed to stop bottoming of shock.
- C. Only one take up spring allowed per corner. Maximum rate 5lbs.
- D. Coil springs must be manufactured from magnetic steel.
- E. Spring preload adjustments for coil springs must be made using mechanical adjusting nuts on the shock body. No coil spring pre-loader assemblies permitted.
- F. One spring rubber per corner is allowed.

#### **19.8.5 – Brakes**

- A. All cars must have four (4) wheel hydraulic brakes in good working condition. Random brake inspection may take place throughout the season.
- B. Carbon fiber, carbon, titanium, ceramic, aluminum pads and/or rotors will not be permitted.
- C. No floating mounted brake calipers.
- D. Brake bias may be adjustable through the cockpit.
- E. Manual brake shut offs will be permitted. An electronic brake shut off switch will also be allowed on the right front only.
- F. Rear brake calipers must be approved aluminum 4 piston designs and must be operational. Maximum rotor diameter 12.19" diameter by 1.25" thick and must be vented. No solid rotors with the exception of the 3/8" rotor.

#### **19.8.6 – Wheelbase and Tread Width**

- A. The minimum wheelbase is 106"-inches and a maximum of 110"-inches with a maximum tolerance of ½", when measured from the centerline of the rear axle to the centerline of the front axle for both left and right sides.
- B. The maximum front tread width will be 86"-inches with a minimum of 74"-inches. The maximum rear tread width will be 86"-inches with a minimum of 80"-inches. These measurements will be taken from the outside edge of the sidewall of the tires on each side with a maximum tolerance of ½"

#### **19.9 – Rear-end Droop**

- A. All cars must have underslung 1 ½" (inch) bars under the rear-end with a maximum of a ½" drop below the bottom of the 2 X 4 frame rail. (Please refer to drawing in 19.16).

#### **19.10 – Roll Cage**

- B. Only round magnetic steel tubing 1-1/2" and/or 1-3/4" in outside diameter with a material thickness of 1-3/4"-.095"-inches and/or 1-1/2"-.120"-inches will be permitted.
- C. The roll cage must be an integral and structural part of the frame. All frames built in 2005 and after must have a manufacturer's unique serial number plate visible and positively fastened on the left front roll cage upright. The letters and/or numbers shall not exceed 8 digits and be ½"-inch in height. See drawing 4.7.2
- D. Front and rear roll bars must be positively fastened in a cage-type configuration. Two (2) round horizontal side bars on each side are required. The top side bar must be a maximum of 22"-inches below the top roll bar.
- E. Proper bracing and triangulation on the front and rear roll bars is required. All roll bar bracing material must be 1-1/2"-inches outside diameter with a material wall thickness of .095"-inches. A minimum of one (1) 1" diagonal bar across the top of the roll cage is required.
- F. The rear main roll bar hoop must be a minimum of 26"-inches when measured across the outside-to-outside of the hoop and maintain that measurement from the top to the bottom of the cage. The bottom of the rear main roll bar hoop must be positively fastened (welded) to the 2"x4" frame rails. Outriggers will not be permitted.



- G. The front roll bar hoop must be a minimum of 26"-inches when measured across the outside-to-outside of the hoop and maintain that measurement from the top to the bottom of the cage, with the exception of the allowable frame taper. Outriggers will not be permitted. Refer to the drawing in the back of this rule book.
- H. MANDATORY Frame/Roll Cage update: A piece of tubing, a minimum of 1-1/4" in outside diameter and .095"-inches in thickness, must be installed vertically and must extend through the car into the bottom frame rail or extend back to the union at the top of the door and rear main hoop joint. The tubing must be installed in a manner that does not impede the driver exiting the cockpit. The tubing must be mounted a minimum of 9" inches and a maximum of 12"-inches on the roof bar from the existing rear roll cage hoop. This must be installed symmetrically on both sides of the roll cage. Existing cars must be retrofitted with this piece of tubing.

### **19.11– Wheels**

- A. Aluminum or steel wheels will be permitted for competition. Magnesium, steel, carbon fiber and/or any other exotic type material will not be permitted.
  - B. 'Bleed-off' and/or 'Bleeder' valves will not be permitted.
  - C. The maximum rim width will be 14"-inches when measured from the inside of left bead to the inside of the right bead of the wheel. Only wheels 15"-inches in diameter will be permitted.
  - D. Beadlocks will be permitted. Any wheel utilizing a beadlock must maintain a minimum diameter hole of 11" or 5" inches inside the beadlock and the wheel. Beadlocks may only be used on the outside of the wheel.
  - E. Wheel spacers must be aluminum.
  - F. Maximum wheel weight 28 lbs. Weights of any kind, added to wheels other than conventional balancing, are not permitted.
  - G. Wheel covers: it is highly recommended that wheel covers have a minimum of 5 mounting points. However, both 5 and 3 mounting point wheel covers will be allowed for competition under the following conditions: Wheel covers having a minimum of 5 attachment points may continue to use steel dzus fasteners. Said dzus fasteners must be made of steel only. No Adjustable expansion mounting rings allowed.
  - H. No Plastic Wheel Covers
  - I. Wheel covers having only 3 attachment points must be bolted-on at all 3 points utilizing a minimum 5/16", flanged steel bolt and an approved fastening (nut assembly) system.
  - J. Approved fastening (nut assembly) systems:
    - i. Keyser Manufacturing: Part #100 7-101.
    - ii. Wehrs Manufacturing: Part # WM377A-312 (Aluminum 5/16) / WM377S-312 (Steel 5/16)
    - iii. Triple X Chassis: Part # SC-WH-7810 (for a 1" spring) / SC-WH-7820 (for a 1 3/8" spring)
    - iv. Smith Precision Products: Part # MC-516-18
- Optional fastening systems that are equal or superior to the above-approved system will be readily approved at the sole discretion of Technical Officials.
- K. Foam inserts may be permitted.
  - L. A minimum of five (5) lug nuts on the rear wheels will be required. A minimum of three (3) lug nuts will be required on the front wheels. Knock off hubs of any type on any wheel will not be permitted.

### **19.12 – Tires**

- A. Only Hoosier Racing Tires will be permitted in any DIRTcar sanctioned events. Hoosier (the tire manufacturer) will mark/stamp/brand all legal tires with specified compound and/or other specific DIRTcar designations as listed below

**Big Block, 358 Modifieds and Sportsman:**

- 2.) D300
- 3.) D400
- 4.) D500

**Tire Size and Compound Designation:**

- Left Front - 11/82-15
- Right Front - 13/82-15
- Left Rear - 13/87-15
- Left Rear – 13/89 - 15
- Right Rear - 13/92-15

- B. The altering of any tire compound, by any means will not be permitted. Chemical alteration of the tread carcass and/or tread compound, such as tire 'soaking' and or the introduction of tread 'softener' and/or the physical defacement (removal, altering and/or covering) of tire sidewall markings in any manner will not be permitted. If any competitor is found to have altered their tires any penalty deemed appropriate by Super DIRTcar Series and/or DIRTcar Officials may be issued. Tires may be protested by another competitor following the protest rules as stated in section 11.2.
  - 1. Any tire may be inspected and/or analyzed for alteration at any time. This will consist of a process as determined by the independent laboratory that performs the analysis. A "Chain of Custody" process will be outlined with the competitor upon inspection of the tires.
  - 2. The analysis process will require shipment of the tire to the selected laboratory. Additional race event(s) may be completed before a determination is made. If a penalty is issued, the event(s) that fell into the analysis time period while the tire(s) were being analyzed may be considered as part of the penalty time period.
  - 3. Reference Section 5.3.D. for Competitive Analysis, Section 11.1.S & T for Penalties and/or Section 11.2.I for Protest(s).
- C. Removable duct tape, provided it does not deface the tire, to cover the D-Number will be permitted.
- D. Heating of the tires by torch, blanket, heating device(s), exhaust system and/or any other method will not be permitted.
- E. Inner liners or sidewall stiffeners of any type will not be permitted.
- F. A tire durometer may be used during the tire inspection process, provided baseline tire(s) have been read at the event prior to inspection.

## **19.13 – Personal Safety Equipment**

### **19.13.1– General**

- A. Each competitor is the solely responsible for the effectiveness and proper installation, per the manufacturer's specifications, of personal safety equipment and determining it to be adequate for competition at every event. Each competitor is expected to investigate and educate themselves for continuing improvement regarding their own personal safety equipment.
- B. Different safety regulations may be in place depending on the local and/or state government rules and/or laws and/or regulations in the specific location of the racetrack. Helmet and seat belt dates and/or specified equipment requirements, worn, utilized and/or otherwise may be different than specified in the rule book. Contact your local track officials for more information regarding this.
- C. Each division section (17 to 20) will cover the General and Specific Safety and Personal Protection minimum requirements. All participants are solely responsible to meet the requirements in the specific division

### **19.13.2 – Seat Belt / Restraint System**

- A. Each car must be equipped with minimum of an SFI 16.5 or SFI 16.1 approved restraint system. Restraint system will be eligible for use in competition until the expiration date or for 2 years from date of manufacturer. Seat belt restraint systems shall be installed and used in accordance with manufacturer's instructions.
- B. In any type of manufacturer's installation, the fasteners must be as supplied by the manufacturer.
- C. Seat belt material should not be permitted to come in contact with any sharp or metal edge, including when the material passes through the seat.

### **19.13.3 – Protective Clothing**

- A. All drivers will be required to wear a fire-resistant driving uniform meeting minimum of the SFI 3.2A/5 specification and display a valid SFI 3.2A/5 label on the outside of the uniform.
- B. Drivers must wear gloves at all times they are on track. Driver's gloves must meet or exceed the SFI 3.3 specification and have a legible and valid SFI 3.3 label.
- C. Drivers must wear shoes that meet minimum of the SFI 3.3 specifications and display a valid SFI 3.3 label.

### **19.13.4 – Seats**

- A. All current seats must be full containment type constructed of aluminum or approved carbon fiber and must adhere to the general design specifications of SFI 39.2 seat construction standards. Design shall include comprehensive head surround, shoulder and torso support system, energy impact foam, and removable head foam.
- B. Carbon fiber seats must have a current valid SFI 39.2 certification.

- C. SFI 39.2 seat compliance is recommended for World of Outlaws Late Models, Super DIRTcar Series, DIRTcar 358 Modifieds, DIRTcar Late Models & Pro Late Models, DIRTcar Sportsman, UMP Modifieds and Pro Modifieds, DIRTcar Pro Stocks.
- D. Seats must be used as supplied and installed following instructions provided by the seat manufacturer
- E. If the left side head surround is 7 inches or less when measured from the back of the headrest, then a left side head net meeting the SFI 37.1 must be installed with a quick release latch. A minimum left side head surround of 4 inches is required.

#### **19.13.5– Helmets**

- A. All drivers must wear a full-face helmet with a minimum safety rating of FIA 8860-2018, Snell SA 2020, Snell EA 2016, Snell SA 2015.

#### **19.13.6 – Head and Neck Restraints**

- A. Drivers, at all times they are on the track, must have their helmets correctly (following manufacturers installation and use instructions) connected to an approved head and neck restraint.
- B. The head and neck restraint must be SFI 38.1 approved and display a legible and valid SFI 38.1 label.

#### **19.13.7 – Fire Suppression**

Required for Late Models, Super DIRTcar Series, Big Block Modifieds, DIRTcar 358 Modified, DIRTcar NE Sportsman and DIRTcar NE Pro Stock. It is recommended for all other divisions.

- A. All racecars shall be equipped with a thermally deployed automatic fire suppression system. The fire suppression system will consist of a DOT approved cylinder manufactured from aluminum or steel with a capacity of ten (10) lbs. of fire extinguishing agent, steel or steel reinforced lines, and has a minimum of two (2) thermally activated discharge nozzles.
- B. All systems must meet or exceed SFI 17.1 specifications. **SFI Label must not be expired and easily accessible for tech officials to read.**
- C. Systems must be fully charged with ten (10) lbs. of DuPont FE-36, 3M NOVEC 1230, FireAde or 4Fire and display a legible and valid SFI and manufacturer label depicting fire extinguishing agent, capacity, and certification date. Cylinders that are beyond useful certification date must be inspected, serviced and re-labeled by the manufacturer.
- D. Cylinders must be mounted forward of the fuel cell. Cylinders must be securely mounted to the frame/roll cage assembly. The certification label must be unobstructed and easily accessible for inspection when the mounting is complete. For systems with one activation point, the activation point may be mounted in the cockpit or rear of the car close to the fuel cell.
- E. The cylinder must be connected to the nozzles with steel or steel reinforced lines.
- F. Two (2) thermally activated nozzles must be used. One (1) nozzle must be located directly above the fuel cell in the fuel cell area and the second nozzle located in the driver cockpit area.
- G. An optional manual override cable is recommended for two (2) thermal automatic nozzle systems but is mandatory for systems with one (1) activation point.
- H. Fire Suppression bottles must remain on during all racing events. If a bottle is found to be turned off during an event, a fine of \$100 will be put in place. A second offense to the same driver will result in a \$300 fine. Third offense will result in disqualification, loss of points and money along with probation.
- I. If a Fire Suppression Bottle is found to have been tampered with at discretion of DIRTcar officials it will be a \$500 fine.

#### **Super DIRTcar Series, Big Block Modifieds, 358 Modified, Sportsman only.**

- A. Cylinders must be mounted forward of the fuel cell just above the deck or below the deck.
- B. Cylinders must be securely mounted to the frame/roll cage assembly and centered in the chassis horizontally.

#### **19.13.8 – Other**

- A. Only SFI 45.1 roll bar padding may be used. Knee, steering pads and/or additional padding may be utilized.
- B. All teams should have an easily accessible fire extinguisher or its equivalent in the team's pit area.

#### **19.14 – Other**

- A. Cars will not be permitted to make a qualifying attempt without passing technical inspection. All cars must be available for inspection prior to the time of the driver's meeting. All cars must come to inspection race ready, if not, car will not be inspected and asked to return to the pit area to make proper changes. Following the driver's meeting, covers of any-type on the racecar will not be permitted.
- B. All fuel lines, power steering lines and/or fittings running through the driver's compartment must be made from a braided or other approved type line. Plastic and/or glass fuel filters will not be permitted.
- C. All cars may be subject to technical inspection at any time.
- D. Full or partial car covers will be permitted only when there is inclement weather, and/or the car is in its designated pit stall. All covers shall be removed prior to the car leaving its designated pit stall.
- E. Roll bar padding mandatory on all roll bars that helmet may come in contact with. Knee and steering pads and/or padding is recommended.
- F. All teams must have a fire extinguisher in the rear of their transporter with the car number clearly visible on the extinguisher. The fire extinguisher must be a minimum of 20lbs and is recommended to FFF type chemical and/or DuPont FE-36 and/or equivalent.
- G. Fire Suppression Systems Cylinders are mandatory and must be mounted forward of the fuel cell, behind the seat below the deck or just above the deck (Pro Stocks should be below deck or mounted inside the cockpit, right-side of driveshaft and must be easily visible). Cylinders must be securely mounted to the frame/roll cage assembly and centered in the chassis. SFI certification along with manufacturers date must be clearly visible.
- H. All drivers are required to have a one-way radio. The one-way radio must be working and active prior to any 'on-track' activity. Two-way radios, crew-member to driver and/or any other means of electronic communication, other than the one-way radio will not be permitted. ONEWAY RADIO MUST NOT BE ABLE TO SWITCH BETWEEN TWO OR MORE PROGRAMMABLE CHANNELS.
- I. Seven (7) days prior to any scheduled and/or sanctioned one (1) day DIRTcar Northeast Series event paying less than \$20,000-to-win race teams will not be permitted to rent, test and or attend any practice session(s) at the scheduled track, unless approved by DIRTcar. Any race team and/or driver in violation will be given one (1) lap of qualifying and the best their qualifying position that will be earned is 50% + 1 of the entered cars for that event.

### **19.15 – Series Decal and Patches**

- A. All participants will be required to display decals as provided on the decal verification sheet prior to entering into competition. If any required decal is not displayed loss of any awarded money will be the penalty.
- B. A series decal is required on both sides of the car. Driver must display the series patch on their uniform to receive point fund awards.

Contingency and sponsorship awards; any team participating must meet the requirements of the award(s) such as decals, patches, product use and verification. There will be a written deadline presented to the teams prior to the start of each season for each element to be in place for the award requirements. If it is an existing program it will roll over from the prior season and the program will begin at the first race of the season.

### **19.16 – Drawings/Photo Descriptions**

#### **Mandatory Decal Placement all Series;**



### **Body Dimensions**

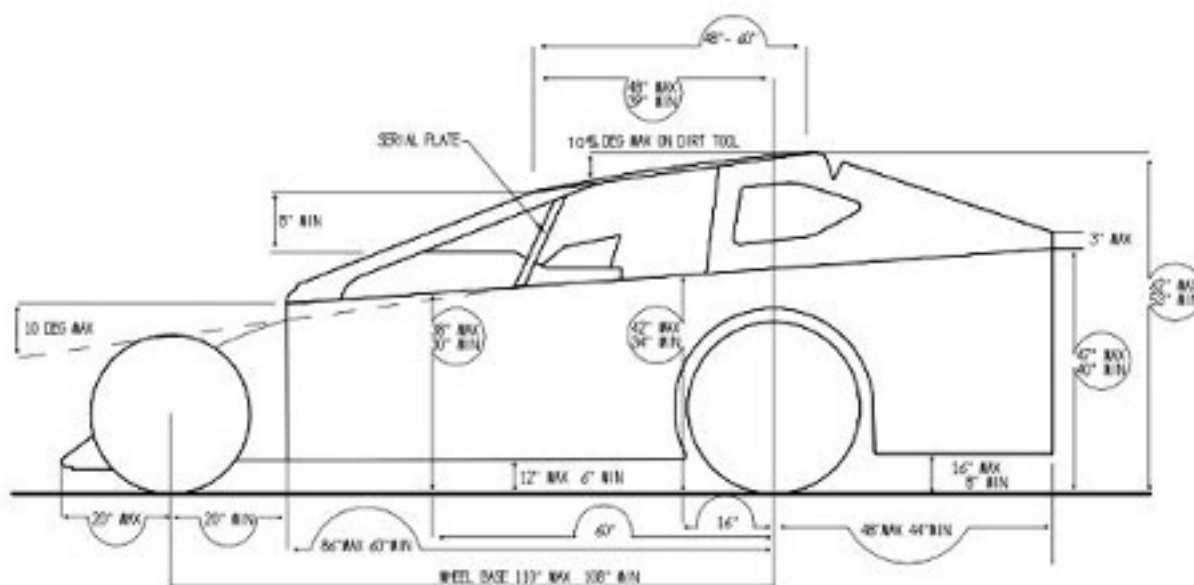

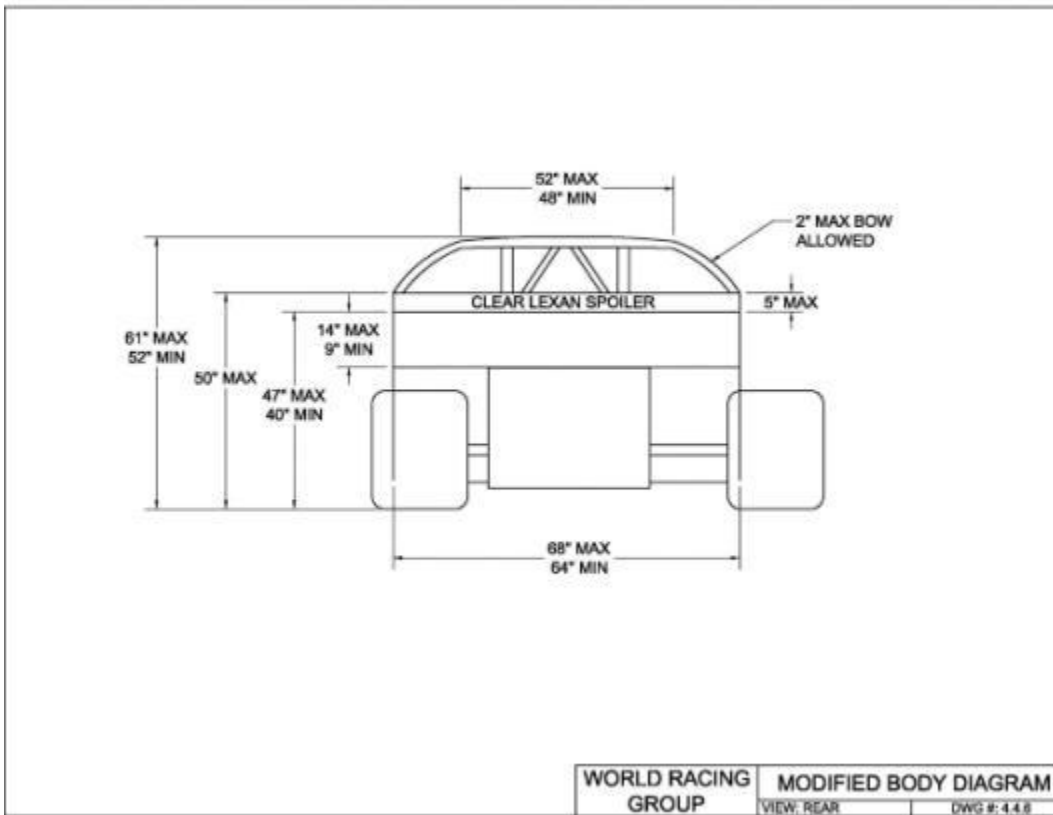

**Chassis Diagram**

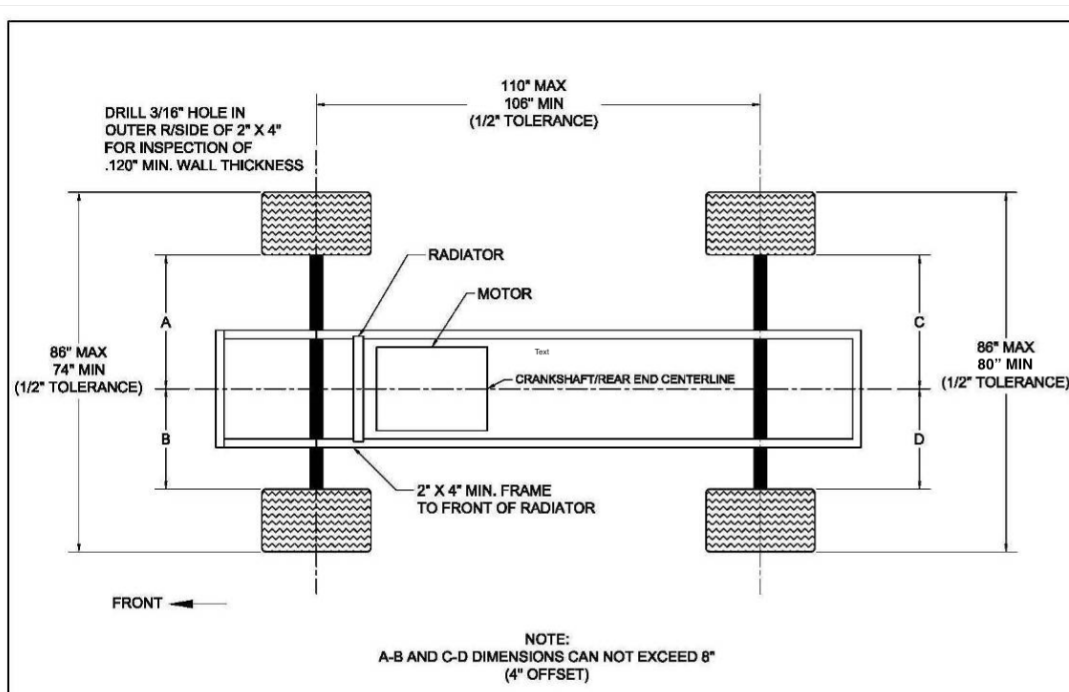

**Rear-end Droop**

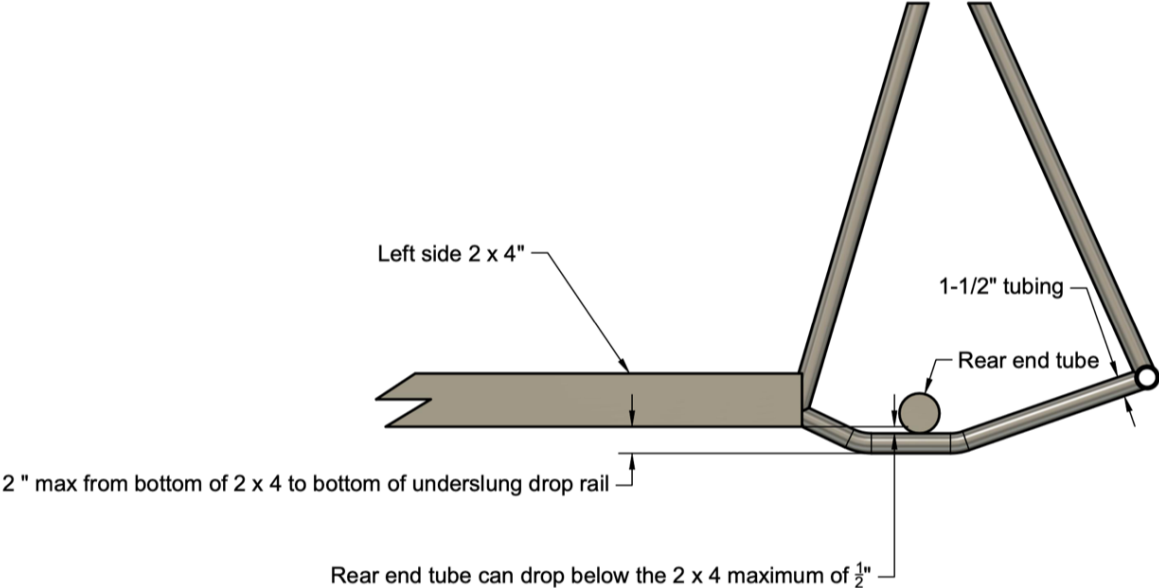

**Transponder Location**

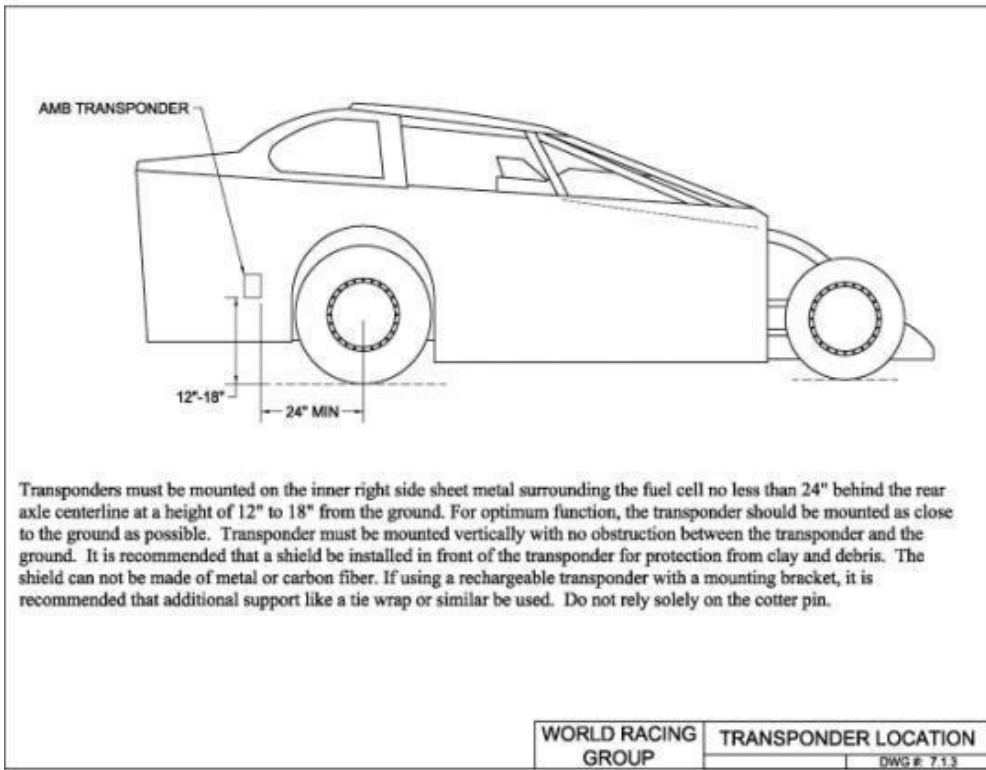

**Front Bumper**

**NOTE:**  
**BUMPERS MUST BE CONSTRUCTED OF 1 1/4" X 0.095 TUBING AND MAINTAIN A HEIGHT OF 18" MEASURED FROM THE GROUND TO THE MIDDLE OF THE BUMPER**

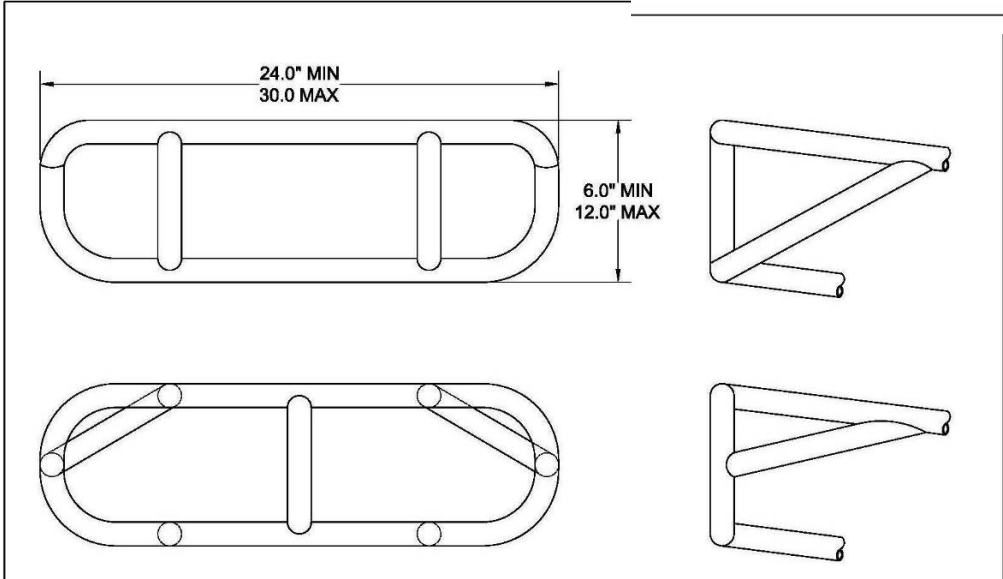

**Roof Angle ( Max. 10 Degrees)**



OFFICIAL MEASUREMENT TECHNIQUE

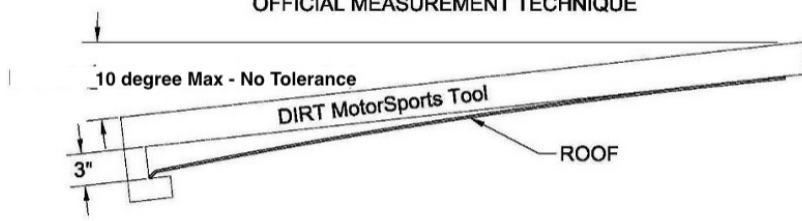

Do not take measurements at the top lid, as it will always be bigger to fit over the canister! The numbers will vary with different shape cells!

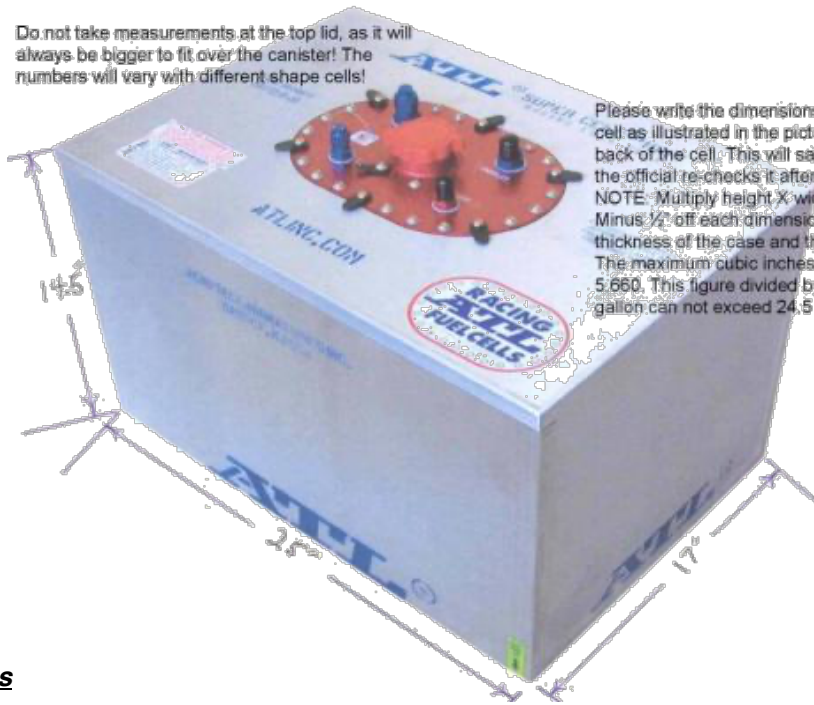

Please write the dimensions of your fuel cell as illustrated in the picture on the back of the cell. This will save time when the official re-checks it after the race.  
NOTE: Multiply height X width X length. Minus 1/2" off each dimension for the thickness of the case and the bladder. The maximum cubic inches allowed is 5,660. This figure divided by 231 c.i. per gallon can not exceed 24.5 Gallons!!

**Fuel Cell Straps**

